

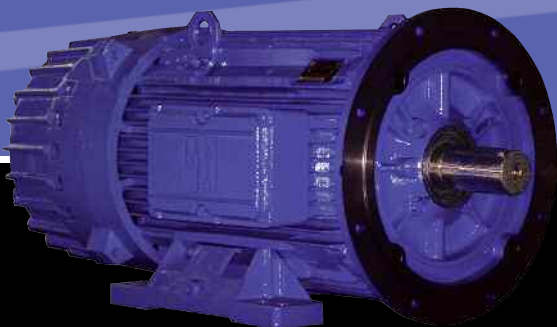

---

# BAH-BAHS series Brake motors





## BAH-BAHS series

### Overview

MGM Electric Motors was established in 1950 as a brake motors manufacturer. MGM is today a world leading manufacturer of this line of products. MGM brake motors are designed and assembled as an integral brake motor unit and not as a mere assembly of a motor with a brake. The perfect engineering and assembling combined with a strong and safe brake, make these motors very reliable.

### BAH series

BAH series motors are three phase, asynchronous brake motors totally enclosed fan cooled (TEFC). BAH series range starts from 180 and continues up to 315 IEC frame size. The brake engages stopping the motor when the brake and the motor are not powered (i.e. power supply failure). BAH series brakes are suitably designed for dynamic braking even though they can be used as static brakes. The braking action is always secured through a very quick and precise stop, assuring a safe and prompt stop every time the motor and the brake are not powered. The brake provides equal brake torque in both directions of rotation, securing a stop without axial shaft sliding. MGM provides AC 3-phase voltage brakes as standard. All the motors, brakes, heaters and monitor wirings are connected into one oversized terminal box so that a separate terminal box is not required for the brake. BAH series brake motors are IP 55 enclosure rating as standard and IP 56 is provided as an option.

BAH series motors are designed to resist overheating and overloading situations in order to guarantee the best reliability under the toughest operating conditions. BAH series standard insulation class is F while class H is available on request. The brake lining has a large surface allowing high brake torque, low disc wear and, consequently, low maintenance cost. The brake torque is adjustable by easily adjusting a few nuts. The MGM brake motor is specially designed to have a self-ventilated friction surface allowing high brake workloads and to maintain a steady braking torque and time. The brake lining is asbestos free.

Frames, shields and flanges are cast iron made; The terminal box is positioned on the right hand side (Drive End view) as standard. The brake friction surfaces are made of cast iron. The brake moving element are build with a laminated core to reduce the electrical losses and securing a very quick brake action.

BAH series main features are: sturdy construction, quick braking action, steady braking times, high number of permissible start/stop cycles also with severe application, adjustable brake torque, low maintenance costs.

### BAHS

The BAH series is also available in the BAHS, not self-ventilated version. BAHS series motors are three phase, asynchronous brake motors totally enclosed not ventilated (TENV). BAHS series brake motors are IP 56 enclosure rating as standard.

### Power Range ( $\frac{kw}{hp}$ )

TYPE	2 poles	4 poles	6 poles	8 poles	2 / 4 poles	4 / 8 poles	2 / 8 poles	4 / 16 poles
180 LA	22.0 30.0	18.5 25.0			17.0/14.0 22.8/18.8	11.0/8.0 15.0/10.9		13.2/3.0 18.0/4.0
180 LB		22.0 30.0	15.0 20.0	11.0 15.0	20.5/17.0 27.5/22.8	14.0/9.0 18.8/12.0	16.0/4.0 21.7/5.5	
200 LA	30.0 40.0		18.5 25.0	15.0 20.0		18.0/11.0 24.0/15.0		
200 LB	37.0 50.0	30.0 40.0	22.0 30.0		24.0/20.0 32.2/26.8	21.0/13.0 28.2/17.4	18.5/4.5 25.0/6.1	16.0/4.0 21.4/5.5
225 S		37.0 50.0			37.0/30.0 50.0/40.0	30.0/18.0 40.0/24.0	24.0/6.0 32.2/8.0	19.0/4.8 25.3/6.6
225 M		45.0 60.0	30.0 40.0	22.0 30.0	45.0/35.0 60.0/47.0	35.0/25.0 47.0/33.3	30.0/7.5 40.0/10.0	24.0/6.0 32.2/8.0
225 MX			37.0 50.0					
250 M		55.0 75.0	37.0 50.0	30.0 40.0		42.0/30.0 58.0/40.0		30.0/7.5 40.0/10.0
280 S		75.0 100.0	45.0 60.0	37.0 50.0		45.0/33.0 60.0/44.0		40.0/10.0 53.5/13.5
280 M		90.0 120.0	55.0 75.0	45.0 60.0		55.0/40.0 75.0/53.5		50.0/12.5 67.0/17.0
315 S		110.0 150.0	75.0 100.0	55.0 75.0				
315 M		132.0 180.0	90.0 120.0	75.0 100.0		86.0/58.0 115.0/78.0		

BAH Series

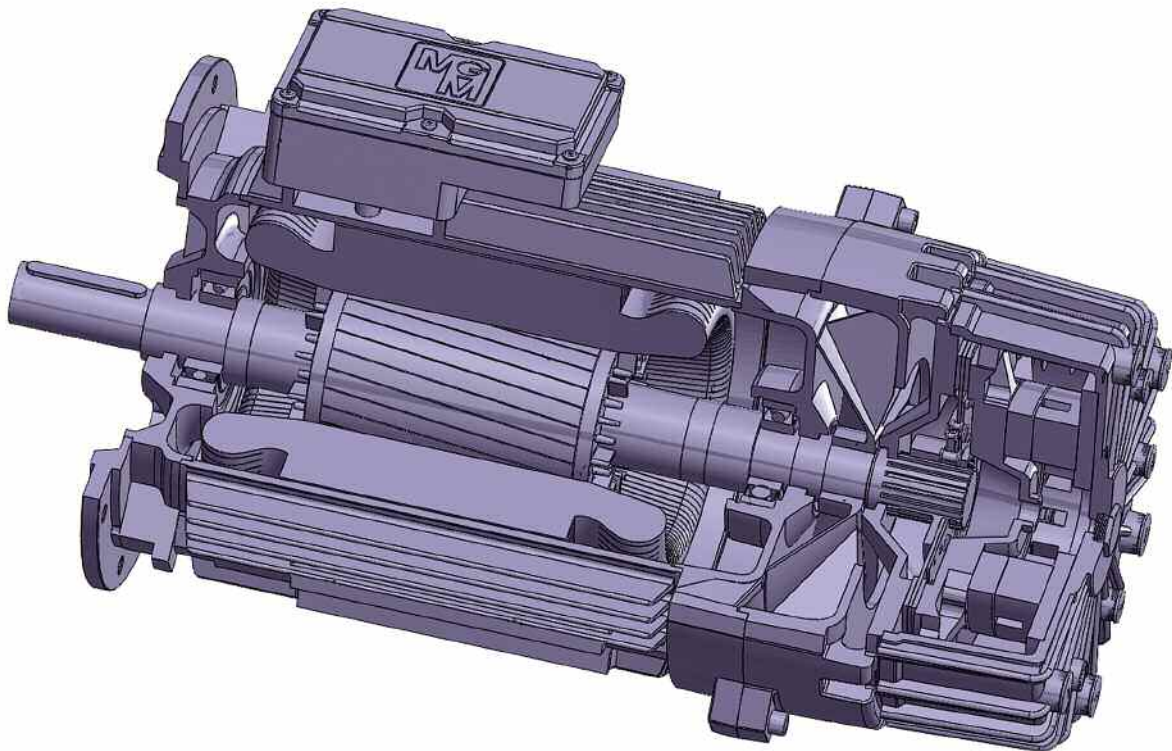

BAHS Series

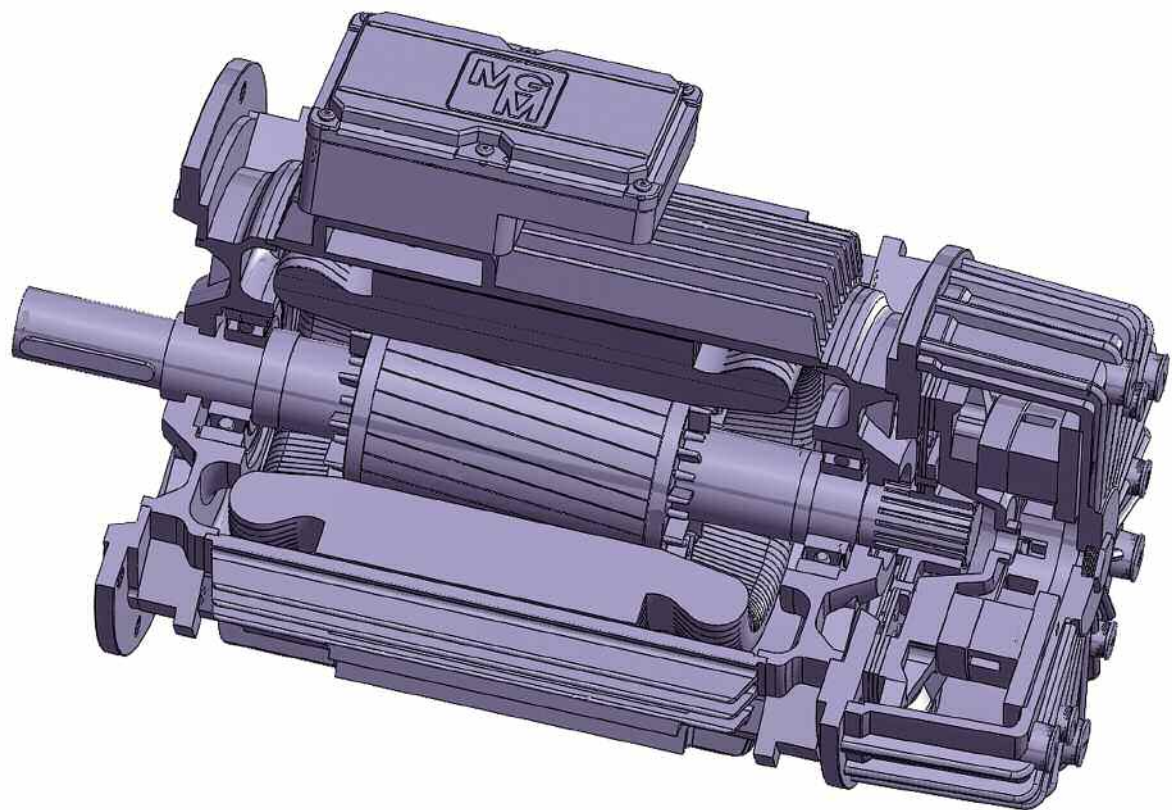



### Brake

The brake engages stopping the motor when the brake and the motor are not powered (i.e. power supply failure). The brake is suitably designed for dynamic braking even though they can be used as static brakes. The braking action is always secured through a very quick and precise stop, assuring a safe and prompt stop every time the motor and the brake are not powered. The brake torque remains the same in both directions of rotation and the motor brakes without axial shaft sliding. As standard the brake is AC 3-phase voltage. The brake connections are taken from the motor terminal box. On request the brakes can be supplied with a manual release (locking or not locking type).

### Brake torque

BAH/BAHS brake torque is factory set to 60-70% of the maximum brake torque indicated on the nameplate. On request the brake torque can be factory set to client specification within the admissible range. The brake torque is proportional to the brake spring compression. The brake torque can be easily adjusted by tightening or loosening the spring locknuts. Please refer to the MGM general catalogue to adjust the brake torque to the desired value within the admissible range.

Frame size	180	200	225	250	280	315
Max AC brake torque (Nm)	300	300	400	700	1000	1400
Max AC brake torque (Lb-in.)	2657	2657	3542	6198	8857	13285

### Enclosure Rating (IP protection degree)

IP 55 enclosure rating is standard on BAH series. IP 56 enclosure rating is provided as an option on BAH series and it is standard on BAHS series. Condensation Drain Holes can be provided on request. Drain holes are particularly recommended for motors installed outdoor or used in high humidity environment with intermittent duty applications. Drain holes have to be opened at regular interval times according as a part of the maintenance program for a proper drainage of the water collected inside the motor. Motor mounting position has to be specified in the order to determine the best drain holes position.

### Painting and other treatments

#### External Parts:

- Motors are RAL 5010 (Blue) painted as standard. Other painting colours are available on request.
- Standard painting coat thickness is 40 µm. Thicker coatings ensure higher withstanding capability in corrosive environments. On request coating thickness of 180 µm or 300 µm (offshore paint) can be provided.
- Special painting cycles can be provided on request. Zinc plated brake parts can be requested as an option.

#### Internal Parts:

- Motor winding is tropicalized as standard.
- Internal surfaces of the shields and flanges are painted.
- Special painting (thickness, colour, cycle) can be applied as an option.
- Zinc plated brake parts can be requested as an option

### Materials

Frames, fan cover, shields and flanges are made of cast iron.

The terminal box is made of aluminium for frame sizes 180 and 200 and it is made of cast iron for frame size from 225 to 315.

Brake friction surfaces are made of cast iron.

The brake moving element and brake coil cores are laminated to reduce electrical losses and secure a quick brake action. All the brake external component are made of cast iron (not including nuts, screw, studs etc.).

Fan is made of non sparking polyimide and it can be requested in Aluminium.

### Bearings

Motors are equipped with double seal ball bearings. The bearings are lubricated for life, washers are made of synthetic rubber very resistant to oil and wear. Special grease for bearings or re-lubrication nipples or different bearings are available on request.

### Types of construction (Mounting Type)

The motors are available in types of construction IM B3, IM B35, IM V5, IM B5 and IM V1 (according to IEC 34-7 standard). Other types of construction are available on request. The drain hole positions are determined as a consequence of the construction type. For information about the classifications of other types of construction and mounting, please contact MGM.



## Technical specifications

### Anticondensation heaters

The application of Anti-condensation heaters helps in preventing water from building up inside the motor, as a consequence of the condensation effect due to the motor temperature fluctuations. Anti-condensation heaters application is particularly recommended for those applications with long intervals between two consecutive work cycles. The condensation could permeate the winding causing a short circuit. This instance occurs mostly on larger motors, which contain more air volume inside the frame, allowing more humidity to condensate. Two anti-condensations heaters are applied on the heads of the motor winding. Anti-Condensation heaters must be used to keep the motor temperature as steady as possible and they must be switched off when the motor is powered to prevent the motor from overheating. MGM applies three types of heaters according to the motor size. The anti-condensation heater wires are connected in the terminal box. The writing "SCALD" on the nameplate shows that a motor is equipped with space heaters. Space heaters standard voltage supply is 220/240V. Any other voltage must be specifically requested and has to be agreed on by MGM.

### Protection devices

The use of protection devices is advisable for motors used in special working conditions.

Use of multiple protection device is recommended for BAH and BAH series.

The chart below reports the most effective protection devices for the most frequent occurring problems.

OPERATION CONDITIONS	PROTECTION TYPE		
	FUSES	PROTECTIVE CIRCUIT BREAKERS	THERMAL PROTECTIVE DEVICE ON THE WINDINGS
Excess currents 200% In	no protection	excellent protection	excellent protection
Heavy starts, reversing operation	no protection	partial protection	excellent protection
Stalling	partial protection	partial protection	partial protection
Starting on two phases	no protection	partial protection	excellent protection
Voltage deviations	no protection	excellent protection	excellent protection
Frequency deviations	no protection	excellent protection	excellent protection
Insufficient motor cooling	no protection	no protection	excellent protection

On request MGM is able to supply motors equipped with thermistors (PTC) or bimetallic (PTO) thermal protectors.

**Bimetallic Thermal Protectors (PTO):** three bimetallic sensors in series with normally closed contacts, fitted on the winding heads. PTO controls a switch (not provided with the motor) that cuts off the power supply when getting close to the dangerous motor temperature. The nominal voltage and current are respectively 250 V and 2,5 A A.C. while the intervention temperature is 140°C. The contacts reset to close position once the temperature goes below 35°C. The PTO wiring connections are located on a terminal board inside the main terminal box. The writing "TP" on the nameplate shows that the motor is equipped with PTO.

**Thermistors (PTC):** three thermistors in series (according to DIN standards 44081 and 44802), fitted on the winding heads. The thermistors resistance changes with the temperature and when getting close to the nominal intervention temperature a sharp increase of resistance guarantees a precise intervention of the safety devices. Thermistors only sense temperature so a cut-off device (not provided with the motor) must be used to cut off the motor power supply. The maximum PTC operating voltage is 30 V DC while the intervention temperature is 130°C on class F motors and 140°C on class H motors. The PTC wiring connections are located on a terminal board inside the main terminal box. The writing "TM" on the nameplate shows that the motor is equipped with PTC.

### Special feature and options

MGM manufacturing line includes built-in encoder brake motors. The encoder is located at the Non-Drive end of the motor shaft well protected underneath a cover. Other available common options are open/close brake monitor micro-switches, brake air gap monitor micro-switches, special flanges or shaft dimension.

### CE mark

BAH-BAHS series motors have the CE mark on the nameplate to indicate the conformity to the requirements of 2006/95/CE "Low Voltage Directive" and 2004/108/CE "Electromagnetic Compatibility Directive".

### CSA approval and UL standards

On request BAH-BAHS series motors can be provided with cCSAus approval in conformity with the requirements of UL 1004 "Electric motors" and CSA C 22.2 No. 100 "Motors and generators" for the North American market. The approved motors show the mark  on the nameplate.

### GOST-R approval

On request BAH-BAHS series motors can be provided with GOST-R approval for the russian market.



## Service duty

The most common duty types are described in this paragraph and a method to calculate the permissible power rise-up is given (only for BAH series). Please contact MGM for different types of duty.

### S1

The motor operates with constant load for a period of time sufficient to achieve the thermal equilibrium.

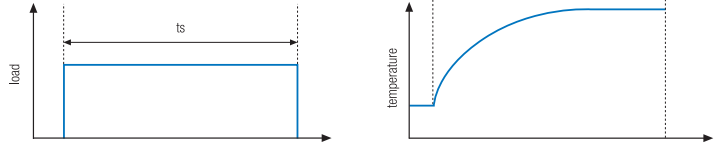

### S2

The motor operates with constant load for a limited period of time not sufficient to achieve a thermal equilibrium. The remaining period of the cycle is a rest period, during which the motor cools down to the ambient temperature again.

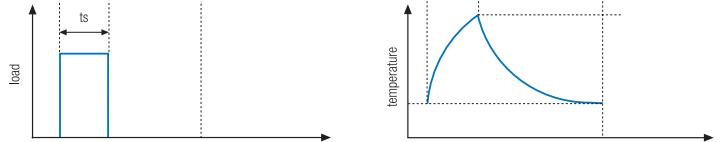

### S3

The motors follows a cycle including an operation period with constant load ( $t_s$ ) and a rest period ( $t_r$ ). The synthetic indication of the duty is given by the intermittent percentage ratio related to a period of time.

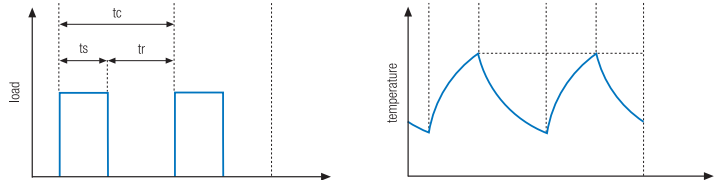

Example: S3 25%

$$\text{Intermittence ratio} = t_s / (t_s + t_r) \cdot 100\%$$

### S4

The motor operates with a sequence of identical duty cycles, each cycle including a significant starting time ( $t_a$ ) and a time of operation at constant load ( $t_s$ ). The remaining period of the cycle is a rest period ( $t_r$ ). Periodic duty implies that thermal equilibrium is not reached during the time on load. The synthetic abbreviation is S4, followed by the cyclic duration factor, the moment of inertia of the motor ( $J_M$ ) and the moment of inertia of the load ( $J_{ext}$ ), both referred to the motor shaft.

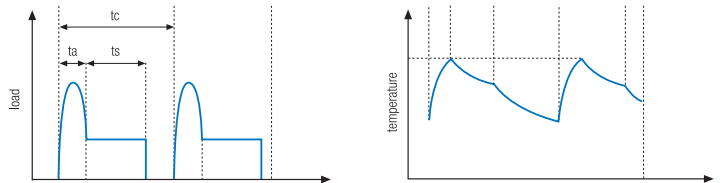

Example: S4 25%  $J_M = 0,15 \text{ kgm}^2$   $J_{ext} = 0,7 \text{ kgm}^2$

$$\text{Cyclic duration factor} = (t_a + t_s) / t_c$$

A motor designed for S1 duty but running on S2 or S3 duty can provide a power output higher than the rated one on S1 duty. However, the starting torque remains the same on all duties. The permissible approximate output power for single speed motors can be calculated as follows:

Power (S3 duty cycle) =  $K \cdot$  Nominal power where  $K$  is a coefficient given by the diagrams (S3) here below.

Power (S2 duty cycle) =  $K \cdot$  Nominal power where  $K$  is a coefficient given by the diagrams (S2) here below.

Power (S4 duty cycle) please contact MGM specifying moment of inertia of the load, starting time and a time of operation at constant load.

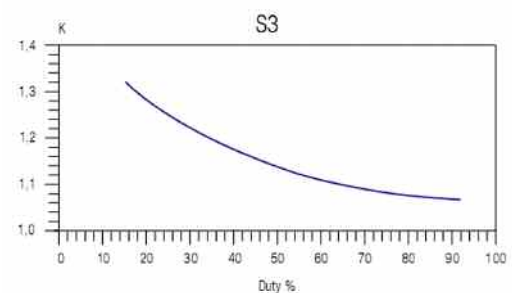
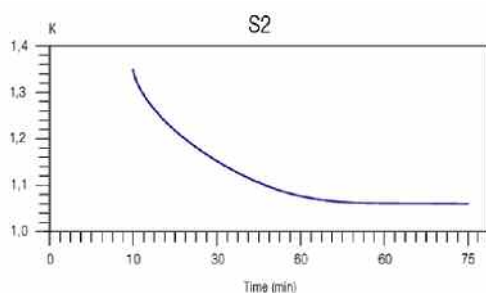



# Dimensions ( $\frac{mm}{inch}$ )

	180L	200L	225S	225M	250M	280S	280M	315S	315M
A	279 10.98	318 12.52	356 14.02	356 14.02	406 15.98	457 17.99	457 17.99	508 20.00	508 20.00
B	279 10.98	305 12.01	286 11.26	311 12.24	349 13.74	368 14.49	419 16.50	406 15.98	457 17.99
C	121 4.76	133 5.24	149 5.87	149 5.87	168 6.61	190 7.48	190 7.48	216 8.50	216 8.50
D	48 1.89	55 2.17	60 2.36	60 2.36	65 2.56	75 2.95	75 2.95	80 3.15	80 3.15
d	M16	M20	M20	M20	M20	M20	M20	M20	M24
E	110 4.33	110 4.33	140 5.51	140 5.51	140 5.51	140 5.51	140 5.51	170 6.69	170 6.69
Fa	18.5 0.73	18.5 0.73	18.5 0.73	18.5 0.73	18.5 0.73	18.5 0.73	18.5 0.73	24 0.94	24 0.94
f	14 0.55	16 0.63	18 0.71	18 0.71	18 0.71	20 0.79	20 0.79	22 0.87	22 0.87
g	42.5 1.67	49 1.93	53 2.09	53 2.09	58 2.28	62.5 2.46	62.5 2.46	71 2.80	71 2.80
H	180 7.09	200 7.87	225 8.86	225 8.86	250 9.84	280 11.02	280 11.02	315 12.40	315 12.40
h	9 0.35	10 0.39	11 0.43	11 0.43	11 0.43	12 0.47	12 0.47	14 0.55	14 0.55
I	14.5 0.57	18.5 0.73	18.5 0.73	18.5 0.73	24 0.94	24 0.94	24 0.94	28 1.10	28 1.10
K	24 0.94	30 1.18	33 1.30	33 1.30	33 1.30	24 0.94	24 0.94	45 1.77	45 1.77
L1	420 16.54	446 17.56	440 17.32	440 17.32	435 17.13	435 17.13	435 17.13	754.5 29.70	780 30.71
Ma	300 11.81	350 13.78	400 15.75	400 15.75	500 19.69	500 19.69	500 19.69	600 23.62	600 23.62
Na	250 9.84	300 11.81	350 13.78	350 13.78	450 17.72	450 17.72	450 17.72	550 21.65	550 21.65
Oa	5 0.20	5 0.20	5 0.20	5 0.20	5 0.20	5 0.20	5 0.20	6 0.24	6 0.24
Pa	350 13.78	400 15.75	450 17.72	450 17.72	550 21.65	550 21.65	550 21.65	660 25.98	660 25.98
Q <sub>BAH</sub>	922 36.30	922 36.30	1035 40.75	1035 40.75	1155 45.47	1155 45.47	1275 50.20	1338 52.68	1389 54.68
Q <sup>1</sup> <sub>BAH</sub>	998 39.29	998 39.29	1147 45.16	1147 45.16	1267 49.88	1267 49.88	1387 54.61	1450 57.09	1501 59.09
Q <sub>BAHS</sub>	807 31.77	851 33.50	920 36.22	920 36.22	999 39.33	1074 42.28	1139 44.84	1226 48.27	1277 50.28
Q <sup>1</sup> <sub>BAHS</sub>	883 34.76	927 36.50	1032 40.63	1032 40.63	1111 43.74	1186 46.69	1251 49.25	1338 52.68	1389 54.68
R1	268 10.55	268 10.55	327 12.87	327 12.87	327 12.87	327 12.87	327 12.87	490.5 19.31	490.5 19.31
S	15 0.59	15 0.59	20 0.79	20 0.79	18 0.71	18 0.71	18 0.71	22 0.87	22 0.87
V	24 0.94	24 0.94	32 1.26	32 1.26	32 1.26	40 1.57	40 1.57	46 1.81	46 1.81
W <sub>BAH</sub>	188 7.40	188 7.40	224 8.82	224 8.82	295 11.61	243 9.57	243 9.57	315 12.40	315 12.40
W <sub>BAHS</sub>	190 7.48	190 7.48	225 8.86	225 8.86	246.5 9.70	246.5 9.70	246.5 9.70	317 12.48	317 12.48
W1	266 10.47	266 10.47	341 13.43	341 13.43	361 14.21	361 14.21	361 14.21	306 12.05	306 12.05
Y	380 14.96	380 14.96	450 17.72	450 17.72	493 19.41	493 19.41	493 19.41	634 24.96	634 24.96
Z1	167 6.57	167 6.57	200 7.87	200 7.87	200 7.87	200 7.87	200 7.87	303 11.93	303 11.93

## BAH B3

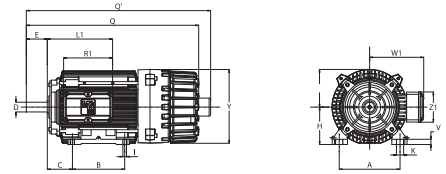

## BAH B5

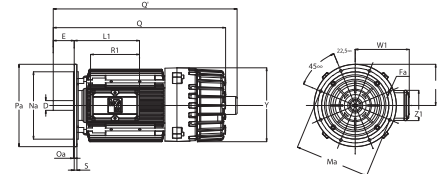

## BAHS B3

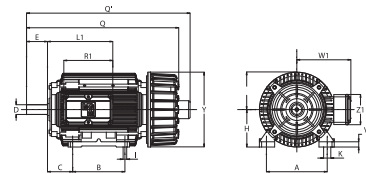

## BAHS B5

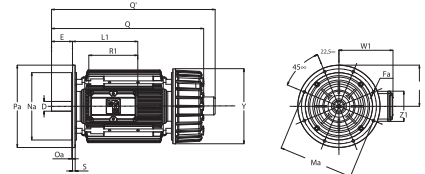

## Shaft End

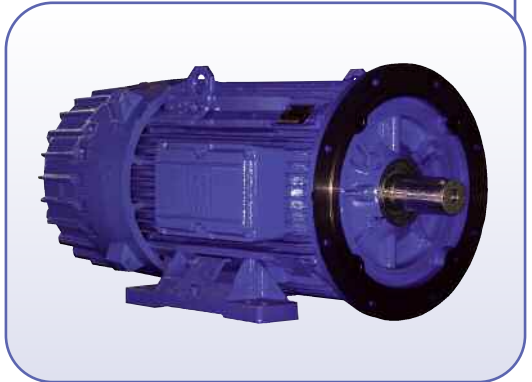
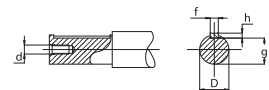



**M.G.M.**  
**motori elettrici s.p.a.**

**Head office and production**

S/R 435 Lucchese Km 31  
I - 51030 Serravalle Pistoiese (PT) - ITALY  
Tel. +39 0573 91511 (r.a.)  
Fax +39 0573 518138  
Web [www.mgmrestop.com](http://www.mgmrestop.com)  
E-mail [mgm@mgmrestop.com](mailto:mgm@mgmrestop.com)



**North Italy branch office**

I - 20090 Assago Milano - Via Fermi, 44  
Tel. +39 02 48843593 - Fax +39 02 48842837

**M.G.M.**  
**electric motors NA Inc.**

**Head office and production**

9731, Métropolitan Boulevard East  
Montréal, Québec H1J 3C1 - CANADA  
Tel. +1 (514) 355 4343 - Fax +1 (514) 355 5199  
Web [www.mgmelectricmotors.com](http://www.mgmelectricmotors.com)  
E-mail [info@mgmelectricmotors.com](mailto:info@mgmelectricmotors.com)